

## BATTERY CHARGER



Installation and User Manual

Rev. 1906



**ATTENTION: To reduce the risk of electric shock, do not remove cover. Refer servicing to qualified service personnel. Disconnect the mains supply before connecting or disconnecting the links to the battery.**



**Read the Instruction Manual carefully before use. Verify that the selected charge curve is suitable for the type of battery You have to re-charge.**

---

Explanation of Graphical Symbols



The lightning flash with arrowhead symbol, within an equilateral triangle, is intended to alert the user to the presence of uninsulated "dangerous voltage" within the equipment's enclosure; that may be of sufficient magnitude to constitute a risk of electric shock to persons.



The exclamation point within an equilateral triangle is intended to alert the user to the presence of important operating and maintenance (servicing) instructions in the literature accompanying the equipment.

---

This product is covered by warranty.

The relative warranty certificate is attached to the Instructions Manual.

If the Manual is not provided with this certificate, please ask your retailer for a copy.

For further references, please write the serial number in the proper space:

**Serial No.** \_\_\_\_\_

## Installation and safety instructions

Battery charger CHFC-3 has been designed to provide safety and reliable. It is necessary to observe the following precautions in order to avoid damage to persons and to the battery charger:

- Read the installation instructions contained in this Manual carefully. For further information put the Manual in a proper place.
- Fix the battery charger to a stable surface through the appropriate holes inserted on the fixing flanges. In case of installation on a vehicle it is advisable to use antivibration supports.
- Preferably the charger should be installed in the vertical position with fans facing up. The horizontal installation is allowed. Never install in the vertical position with fans facing down.
- Ensure all ventilation ports are not obstructed, to avoid the overheating. Do not put the battery charger near heat sources. Make sure that free space around the battery charger is sufficient to provide adequate ventilation and an easy access to cables sockets.
- Protect the battery charger from ingress of water. Do not pour liquids inside the case.
- Verify that the available supply voltage corresponds to the voltage that is stated on the battery charger name plate. In case of doubt, consult a retailer or local Electric Supply Authority.
- For safety and electromagnetic compatibility, the battery charger has a 3-prong plug as a safety feature, and it will only fit into an earthed outlet. If you can not plug it in, chances are you have an older, non-earthed outlet; contact an electrician to have the outlet replaced. Do not use an adapter to defeat the earthing.
- To avoid damaging the power cord, do not put anything on it or place it where it will be walked on. If the cord becomes damaged or frayed, replace it immediately.
- If you are using an extension cord or power strip, make sure that the total of the amperes required by all the equipment on the extension is less than the extension's rating.
- Disconnect the mains supply before connecting or disconnecting the links to the battery.
- To recharge Lead Acid batteries: **WARNING: Explosive Gas – Avoid flames and sparks.** The battery must be positioned in a correctly cooled place.
- Do not use to charge batteries installed on board of thermal engine cars.
- Avoid recharging of non-rechargeable batteries.
- Verify that the nominal voltage of the battery to be re-charged corresponds to the voltage stated on the battery charger name plate.
- Verify that the selected charging curve is suitable for the type of battery to be re-charged. In case of doubt, consult Your retailer. ZIVAN S.r.l. will not accept any responsibility in case of mistaken choice of the charging curve that may cause irreversible damage to the battery.
- In order to avoid voltage drop, thereby assuring 100% charge at the battery, the output cables must be as short as possible, and the diameter must be adequate for the output current.
- In the case of thermal compensation of the battery voltage, it is necessary to place the thermal sensor in the area of highest battery temperature.
- Do not try to service the battery charger yourself. Opening the cover may expose you to shocks or other hazards.
- If the battery charger does not work correctly or if it has been damaged, unplugged it immediately from the supply socket and from the battery socket and contact a retailer.

## Operating principle

The battery charger considerably affects battery life and performances, which is the main part of every electric vehicle.

A non controlled traditional battery charger (rectifier) provides a simple **direct AC/DC** conversion.

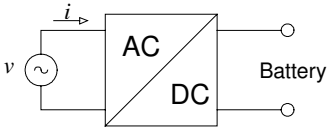

Disadvantages of this solution are:

- Low efficiency
- Large physical size
- Long charge times
- Charge depends on changes in the mains supply (with overcharge danger in the final charge phase)

In modern battery chargers these disadvantages are solved with an **indirect AC/DC** conversion, by passing through an intermediate DC/DC conversion.

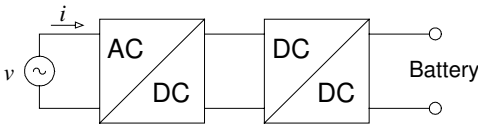

This is the usual method of operation for the SMPS (Switching Mode Power Supply) at high power. This solution gives a good performance for minimum costs and physical dimensions using switches more faster and powerful (modern technology).

The main advantages of this solution are:

- High efficiency
- Reduced dimensions
- Short charge times
- Charge independent from the changes of the mains supply
- Electronic control that provides the desired charge curve

The advent of electrical problems (due to commutation) has imposed the introduction of adequate filtering to satisfy requirements of EMC 89/336/EEC directive for electromagnetic compatibility.

## Block Diagram

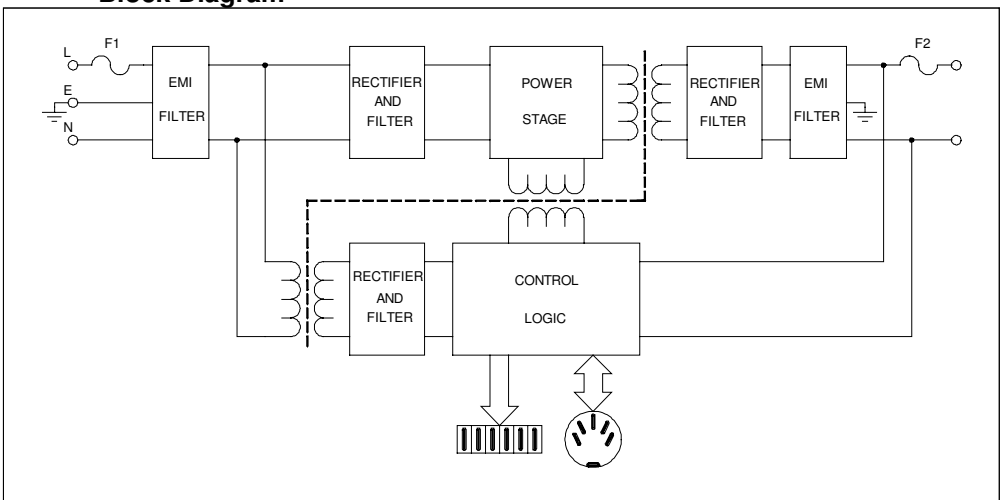

## LED Indicator

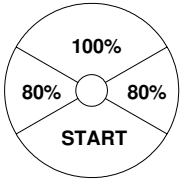

RED LED shows that the battery is in the initial charging phase.  
 Blinking RED LED shows that the battery charger has reached 80-90% of charge.  
 Blinking YELLOW LED shows that the battery charger has reached 95% of charge.  
 GREEN LED shows that the battery has reached 100% of charge.

Further information can be found in the description of the Charging Curve.

**Example:** RED LED on with brief blinks indicates a constant tension phase.

## Alarms (Two-tone audible message)

An two-tone audible message and the flashing LED shows that an Alarm situation has occurred:

| Condition                                | Alarm Type       | Description (Action)  |
|--|------------------|---|
| Audible message + RED flash              | Battery Presence | Battery disconnected or not in conformity. (Verify the connection and the nominal voltage).   |
| Audible message + YELLOW flash           | Thermal Sensor   | The thermal sensor is disconnected during the re-charge or it is out working range. (Verify the connection of the sensor and measure the temperature of the battery). |
| Audible message + GREEN flash            | Timeout          | Phase 1 and/or Phase 2 have a duration in excess of the maximal allowed. (Verify the battery capacity).   |
| Audible message + RED-YELLOW flash       | Battery Current  | Loss of output Current control. (Failure of the control logic).   |
| Audible message + RED-GREEN flash        | Battery Voltage  | Loss of output Voltage control. (Battery disconnected or failure of the control logic).   |
| Audible message + YELLOW -GREEN flash    | Selection        | An unavailable configuration has been selected (Verify the selector's position)   |
| Audible message + RED-YELLOW-GREEN flash | Thermal          | Overheating of semiconductors. (Verify the fan operation).  |

When there is an alarm the battery charger stops supplying current.

## Thermal Sensor and/or External Indicator

Thermal Sensor and External Indicator are Options that have to be connected to the 5 poles socket 180°.

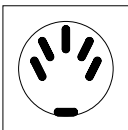

Unless otherwise stated, the compensation of the Battery Voltage in function of the temperature of the Thermal Sensor is of  $-5\text{mV}/^{\circ}\text{C}$  for battery cell.

The control range of the Thermal Sensor goes from  $-20^{\circ}\text{C}$  to  $+50^{\circ}\text{C}$ .

The External Indicator reflects exactly the LED Indicator which is placed on the equipment.

Further information can be found in the description of the Charging Curve.

## Auxiliary Contacts

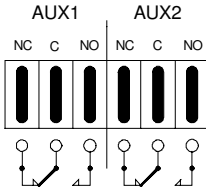

Technical Features: changeovers contacts  
 0,3A 125VAC  
 0,3A 110VDC  
 1A 30VDC

Connector: faston 6,3 × 0,8 mm

Unless otherwise stated, the auxiliary contacts provide the following functions:

| Section | Function   | Description  |
|---------|--|--|
| AUX1    | Mains Presence   | When the equipment is switched on, the contact Normally Open (NO) CLOSES and instead the contact Normally Closed (NC) OPENS. |
| AUX2    | Battery Presence<br>(only on rev TX.7h.cf4 and higher) | When battery presence is detected, the contact Normally Open (NO) CLOSES and instead the contact Normally Closed (NC) OPENS. |

## LED Bar Graph

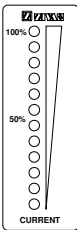

The LED Bar Graph is an Option that shows a percentage indication of output current in comparison with its max. value

## Battery

A battery is characterised by two sizes: tension and capacity.

### Tension:

Each element has a nominal tension, which depends on the type of battery (no matter what size).

In order to reach higher tension, many elements are connected in series, so creating a "BATTERY" of elements.

The number of elements is calculated by dividing the nominal tension of the battery for the tension of each single element in the table:

| Type | Nominal Tension |
|------|-----------------|
| Pb   | 2 V/cell        |
| NiCd | 1,2 V/cell      |
| NiMH | 1,2 V/cell      |
| NiZn | 1,714 V/cell    |

### Capacity:

It is the quantity of electric charge that the batteries can supply to an external circuit before the tension decreases under the final limit value and it is obtained by multiplying the intensity of the discharging current **I**, expressed in ampere (**A**), for the discharging time **t** expressed in hours (**h**): **C = I x t**

The traction battery capacity is normally referred to the discharging system of 5h: **C5 = I x 5h**.

The capacity values that can be recharged by the battery chargers can be found in the description of the Charging Curve (this value is not present in the curves able to charge any capacity).



This device is in conformity with the Low Voltage directive 73/23/EEC and EMC directive 89/336/EEC and their further modifications.

### Mechanical dimensions

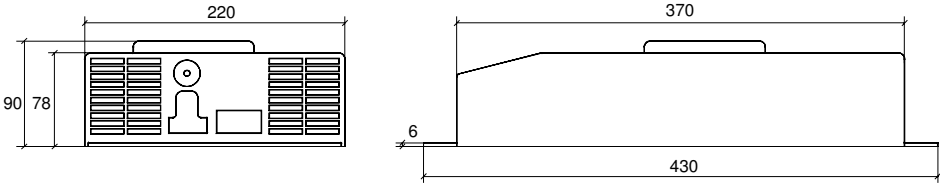

**N.B.** All dimensions are expressed in mm.

### Drilling details

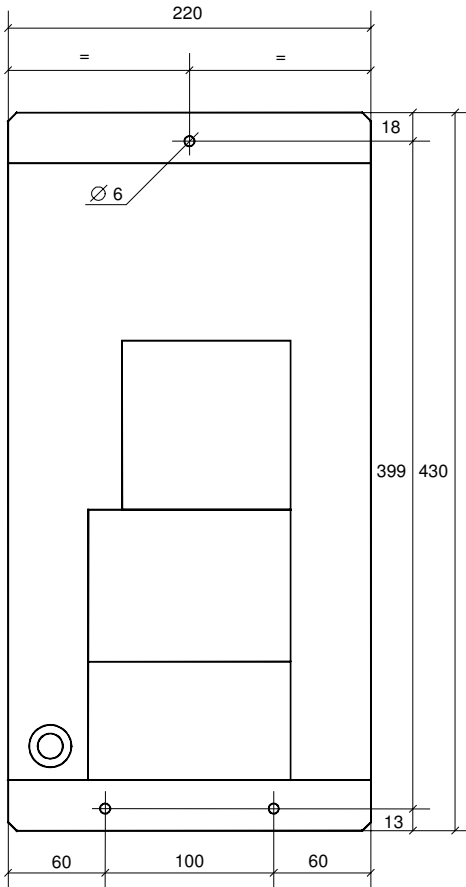

**UP**  
↑  
**Advised Installation**

**N.B.** All dimensions are expressed in mm.

## TECHNICAL FEATURES

Ta=25°C unless otherwise specified

### Mains side

| Description              | Symbol              | Test Condition                        | Value and/or Range | Unit             |
|--------------------------|---------------------|---------------------------------------|--------------------|------------------|
| Supply Voltage           | V <sub>in</sub>     | -                                     | 115 ± 10%          | V <sub>eff</sub> |
| Frequency                | f                   | -                                     | 50 ÷ 60            | Hz               |
| Absorbed Maximum Current | I <sub>in_max</sub> | P = P <sub>max</sub>                  | 20                 | A <sub>eff</sub> |
| Inrush Current           | -                   | V <sub>in</sub> = 115V <sub>eff</sub> | < 1,35             | A                |
| Power Factor             | cosφ                | P = P <sub>max</sub>                  | 0,68               | -                |
| Absorbed Minimum Power   | P <sub>in_min</sub> | End of charge                         | < 5                | W                |
| Absorbed Maximum Power   | P <sub>in_max</sub> | P = P <sub>max</sub>                  | 3                  | kW               |

### Battery side

| Description                            | Symbol              | Test Condition                          | Value and/or Range         | Unit           |
|--|---------------------|---|----------------------------|----------------|
| Output current                         | I                   | -                                       | See curve                  | -              |
| Maximum output current                 | I <sub>1</sub>      | Phase 1                                 | See curve                  | A              |
| Output current ripple                  | -                   | I = I <sub>1</sub>                      | < 5%                       | -              |
| Absorbed current                       | I <sub>a</sub>      | Equipment turned off                    | < 0,5                      | mA             |
| Output voltage                         | U                   | -                                       | See curve                  | -              |
| Constant output voltage                | U <sub>1</sub>      | Phase 2                                 | See curve                  | V              |
| Thermal compensation of output voltage | dU <sub>1</sub> /dT | Phase 2                                 | -5                         | mV / (°C·cell) |
| Operating range of Temperature Sensor  | ΔT                  | -                                       | from -20<br>to +50         | °C             |
| Output voltage ripple                  | -                   | U = U <sub>1</sub>                      | < 1%                       | -              |
| Maximum power supplied                 | P <sub>max</sub>    | U = U <sub>1</sub> , I = I <sub>1</sub> | 2550                       | W              |
| Output capacity                        | C                   | -                                       | Depend on the model (>0,2) | mF             |



## Battery charger CHFC-3

### General

| Description                    | Symbol     | Test Condition              | Value and/or Range | Unit |
|--------------------------------|------------|-----------------------------|--------------------|------|
| Operating range of temperature | $\Delta T$ | -                           | from -20 to +50    | °C   |
| Maximum relative humidity      | RH         | -                           | 90%                | -    |
| Switching frequency            | $f_c$      | -                           | $30 \pm 5\%$       | kHz  |
| Efficiency                     | $\eta$     | At each operation condition | > 85%              | -    |
| Maximum size                   | a×b×c      | Without connecting cable    | 430×220×90         | mm   |
| Weight                         | -          | Without connecting cable    | 5,5                | kg   |
| Enclosure class                | -          | -                           | IP20               | -    |

### Protection and Safety

| Description   | Symbol | Test Condition  | Value and/or Range             | Unit     |
|---|--------|---|--------------------------------|----------|
| Insulation  | -      | Mains to Battery side   | 1250                           | $V_{AC}$ |
| Insulation  | -      | Mains side to Earth   | 500                            | $V_{DC}$ |
| Insulation  | -      | Battery side to Earth   | 500                            | $V_{DC}$ |
| Leakage current   | $I_L$  | Supplied equipment  | < 3                            | mA       |
| Input fuse  | F1     | Inside the equipment  | 25                             | A        |
| Output fuse   | F2     | Inside the equipment  | 125                            | A        |
| Minimum output voltage of operation (Battery Detector)              | -      | Equipment turn on   | 1,5                            | V/cell   |
| Maximum output voltage  | $U_m$  | Phase 3 (IUIa - IUIUo)  | See curve                      | V        |
| Reverse output polarity   | -      | At the connection to the Battery  | Protection provided by fuse F2 | -        |
| Thermal protection of semiconductors (Temperature of Thermal Alarm) | -      | $T_a=55^\circ C$  | 100                            | °C       |
| Safety Requirements (Rules)   | -      | EN60335-1, EN60335-2-29   | -                              | -        |
| EMC Requirements (Rules)  | -      | EN55014-1, EN61000-3-3<br>EN55014-2, EN61000-4-2<br>EN61000-4-4, EN61000-4-5<br>EN61000-4-6, EN61000-4-11 | -                              | -        |

**Cantec**   
Systems

**Your Power Solutions Specialists**

1573 LAPERRIERE AVENUE OTTAWA ON 1Z 7T3

OTTAWA  
Tel: 613-725-3704  
Fax: 613-725-0490

TORONTO:  
Tel: 613-725-3704  
Fax: 613-725-0490

VANCOUVER:  
Tel: 604-736-4922  
Fax: 604-736-1074

A DIVISION OF CANTEC REPRESENTATIVES